

Christmas Gift Boxes

Finished Size: 7 1/2" x 7 1/2" x 6 3/4"



Supplies Needed [to make two boxes]

- 1 pkg. Fabric Palette[®] Fat Quarter Bundle (4 – 18" x 21")
- 1 meter pkg. Fabric Palette[®] coordinating fabric
- 1 3/4 yards Fusible batting
- 1 yard Fusible interfacing (medium weight)
- Coordinating thread
- Rotary cutter, mat and acrylic ruler
- Removable fabric pencil or marker
- Basic sewing supplies
- Sewing machine
- Iron and pressing surface

Before you begin

Read all instructions before beginning project. Do not pre-wash fabrics. Before cutting, press fabrics with a dry iron on cotton setting. Use a 1/4" seam allowance and sew fabrics with right sides together (RST) unless otherwise noted. Press seams in the direction of the arrows.

Cutting

Fabric A:

2 Singles: 7 - 2" x 21" strips

Fabric B:

2 Singles: 6 - 2" x 21" strips

Fabric C (coordinating fabric):

2 – 11" x 30 1/2"

Fusible batting:

2 – 11" x 30 1/2"

Fusible medium weight interfacing:

2 – 11" x 30 1/2"

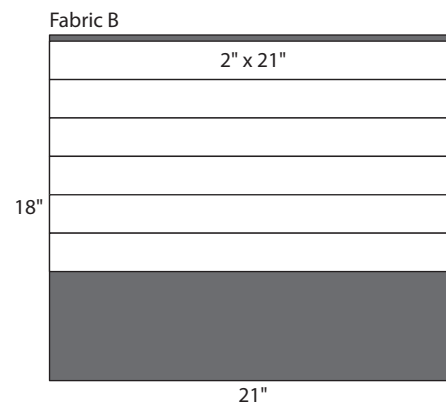
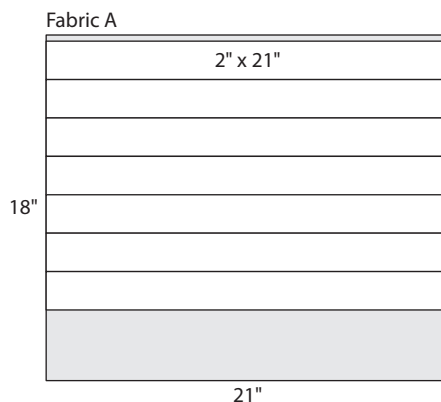

Sewing

1. Pin a Fabric A and Fabric B strip RST so long edges meet as shown; sew and press. Repeat to make a total of six strip pairs. **Note:** *There will be one strip left over.* Sub-cut five strip pairs into 3 1/2" segments for a total of thirty 3 1/2" x 3 1/2" squares. Sub-cut the sixth strip set into five 2" x 3 1/2" segments. Sub-cut the single strip into five 2" x 3 1/2" segments (Dia. A).

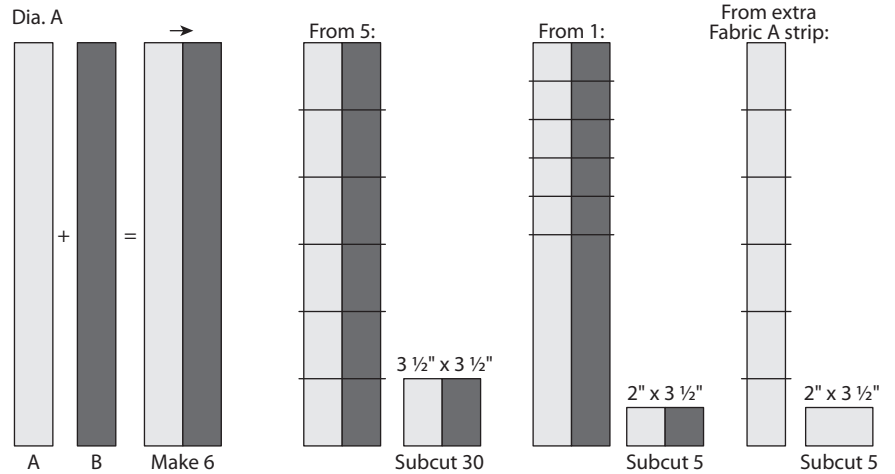

2. Refer to Diagram B to arrange the segments in four rows of ten each; pin RST, sew and press. Sew the rows RST; press. The pieced Box should measure 11" x 30 1/2".

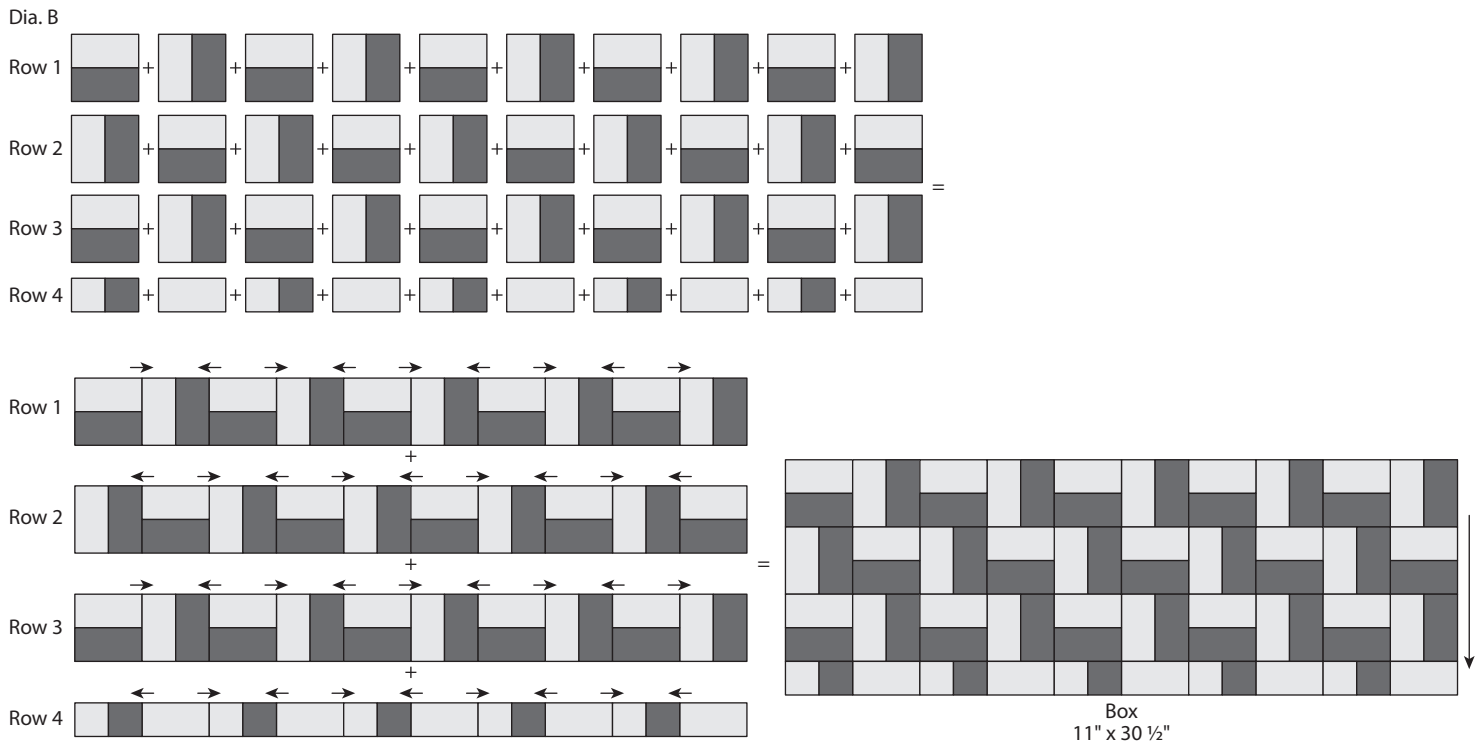

3. Follow the manufacturer's directions to fuse the batting to the **wrong** side of the Box and the interfacing to the **wrong** side of the Fabric C Lining (Dia. C).

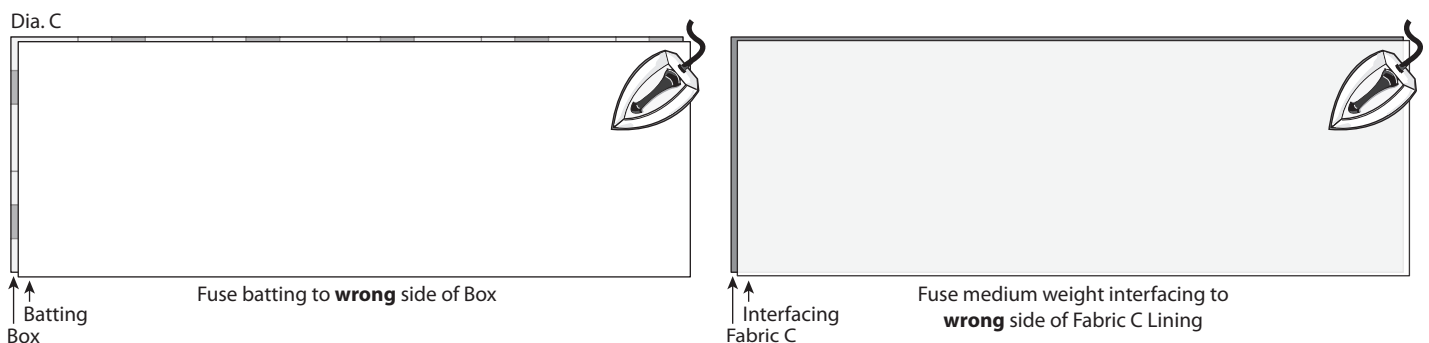

4. Fold the Box in half RST so the short edges meet. Sew the side and bottom edges. Press the folded edge to mark the side opposite the seam, then press seams open. **Tip:** Use a rolled up towel inside the bag to press the seams open. Repeat for the Lining leaving a 5" opening in the center of the bottom edge to turn right side out (Dia. D).

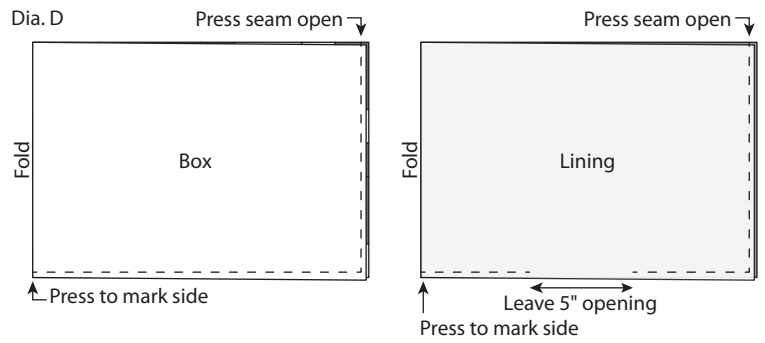

5. To box the bottom, bring the bottom seam to the side seam RST. Mark $3\frac{3}{4}$ " from the point and stitch from edge to edge. Trim the point to a $\frac{1}{2}$ " seam (Dia. E). Repeat for the other side. Turn Box right side out. Press the bottom edges square. Repeat to square the bottom of the Lining. **Note:** Do not turn Lining right side out.

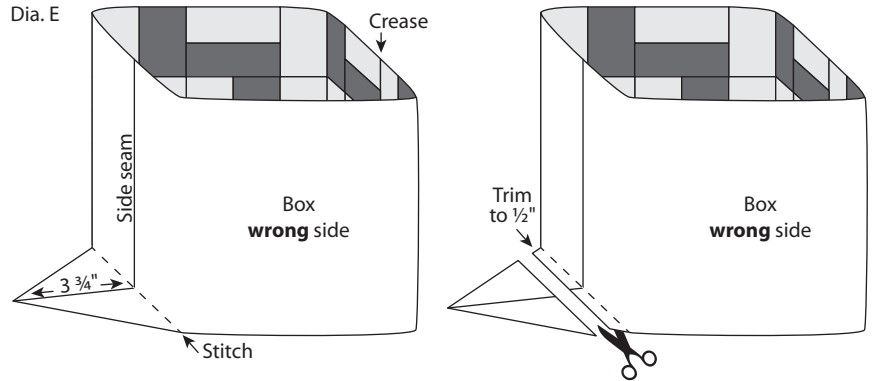

6. Place the Box inside the Lining RST matching the folds and seams; pin and sew around the top edge. Turn right side out through the opening in the Lining (Dia. F). Sew the opening in the Lining closed.

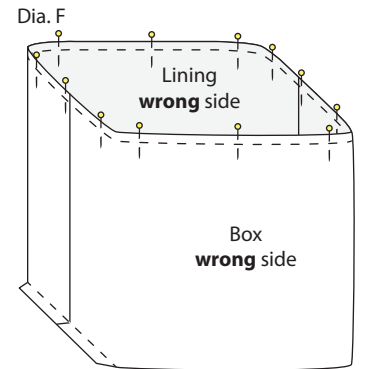

Finishing

7. Push Lining inside the Gift Box. Press the top edge flat then topstitch $\frac{1}{4}$ " from the edge. Turn the Gift Box right side out. Press corners flat to define the edges of the box (Dia. G).
8. Repeat using the remaining two Singles and coordinating fabric to make a second Gift Box.

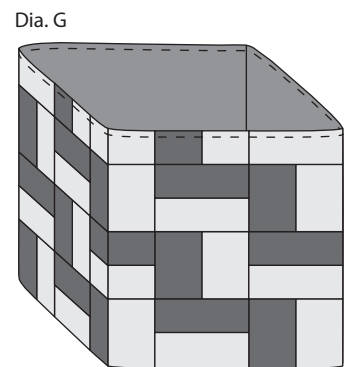

Finished Care Instructions

Wipe with a damp cloth if needed.